

Zarejestrowano / Registered 06/06/2024

No 015062766-0001



**URZĄD UNII EUROPEJSKIEJ DS.
WŁASNOŚCI INTELKTUALNEJ
ŚWIADECTWO REJESTRACJI**

Niniejsze Świadectwo Rejestracji zostało wystawione dla przedstawionego poniżej Zarejestrowanego Wzoru Wspólnotowego. Wszystkie dane dotyczące tego wzoru zapisane są w Rejestrze Wzorów Wspólnotowych.

**EUROPEAN UNION INTELLECTUAL
PROPERTY OFFICE
CERTIFICATE OF REGISTRATION**

This Certificate of Registration is hereby issued for the Registered Community Design identified below. The corresponding entries have been recorded in the Register of Community Designs.

*Dyrektor wykonawczy / The Executive
Director*

João Negrão





21 015062766-0001
25 PL - EN
22 06/06/2024
15 06/06/2024
45 20/06/2024
11 015062766-0001
72 Buszko Marcin
73 Marcin Buszko, POLMAR INVEST Marcin Buszko
ul. Główna 13
73102 Stargard
POLONIA
74 KANCELARIA PATENTOWA PATELHA LUDWIK HUDY
RZECZNIK PATENTOWY
ul. Czernichów 4
32-070 Czernichów/Kraków
POLONIA
51 25 - 01
54 **BG** - Подпори
ES - Soportes [puntales de apoyo]
CS - Podpěry [stojky]
DA - Stivere
DE - Stützen
ET - Toendid
EL - Μέσα υποστήριξης [στηρίγματα]
EN - Supports [props]
FR - Étaçons
IT - Sostegni [puntelli]
LV - Balsti
LT - Atramos [ramsčiai]
HR - Podupirači /kosnici/
HU - Támaszok [dúcok]
MT - Appoġġi [riffieda]
NL - Stutten [schoren]
PL - Podpory
PT - Suportes [escoras]
RO - Suporturi [elemente de sprijin]
SK - Podpery [spojky]
SL - Opore [podporniki]
FI - Tuet [kannattimet]
SV - Stöd [stöttor]
30 -
55 -

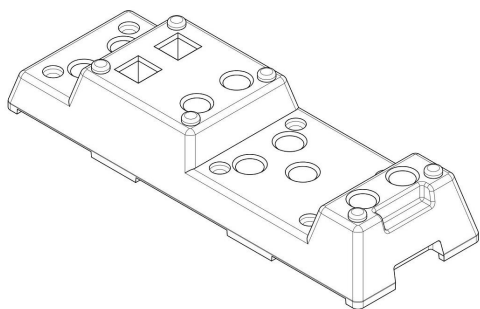

0001.1

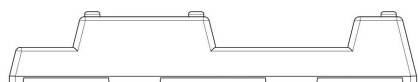

0001.2

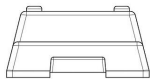

0001.3

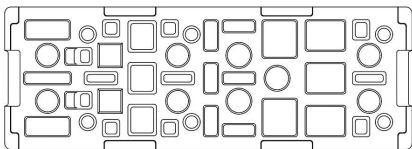

0001.4

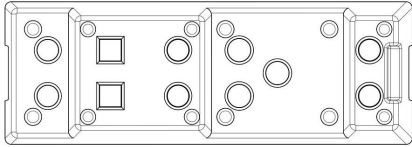

0001.5

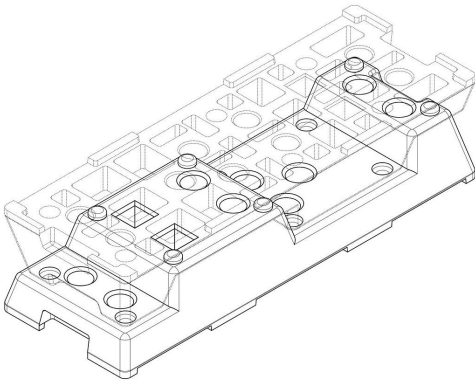

0001.6

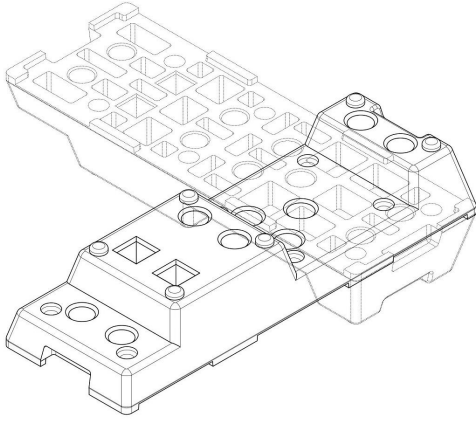

0001.7